



Operating manual

Stator Antenna A9c

Manner Sensortelemetrie GmbH
Eschenwasen 20
D-78549 Spaichingen

Telephone: +49 (0)7424 9329-0
Fax: +49 (0)7424 9329-29

E-mail: info@sensortelemetrie.de
Internet: www.sensortelemetrie.de

11046, 1, en_US

Revision History:

Document code	Date	Modification	Approval
11046, 1, en_US	2019-09-19	Creation of documentation	2019-09-20, von Borcke

Copyright

All rights for duplicating, photomechanical reproduction – also extracts - are explicitly reserved by the enterprise Manner Sensortelemetrie. Trade marks and trade names were used without verification of the free applicability.

Disclaimer Documentation

The texts and examples were prepared with care. Mistakes can not be excluded. The enterprise Manner Sensortelemetrie will assume no liability for missing or incorrect information and resulting consequences, neither judicial nor otherwise.

Modifications

The enterprise Manner Sensortelemetrie GmbH may change or upgrade hardware and software – or parts of them - as well as the provided documents (operation instructions, start-up instructions, spare parts lists) – or parts of them – without notification.

We would be pleased for suggestion for improvement and notes about mistakes.

©September 2019, Manner Sensortelemetrie GmbH

Table of contents

1	Safety	4
1.1	Definition of Warnings.....	4
1.2	General Warnings.....	4
2	Conventional Usage	6
3	Technical Data	7
3.1	Measuring System.....	7
3.2	Stator Antenna.....	8
4	Mounting / Starting	9
4.1	Coupling / Installation (<i>Example</i>).....	9
4.1.1	Instruction for Installation Stator Antenna.....	11
4.1.2	Adjustment of Stator Antenna.....	11
5	Options	13
6	Maintenance	14
7	Contact	15

1 Safety

1.1 Definition of Warnings



DANGER!

Hint for possible dangerous situation. Ignoring the security terms may cause death or serious injury.



WARNING!

Hint for possible dangerous situation. Ignoring the security terms may cause injury.



CAUTION!

Hint for possible damage of property, if the corresponding protective measure were disregarded.



Further information

1.2 General Warnings

The system startup has to be carried out by trained qualified personnel, who is able to evaluate the potential risks. All chapters of this instruction manual had to be read and fully understood before startup.

On non-observance it's not possible to assert a claim for the incurred losses from the manufacturer. Any changes to the system, except those described in the instruction manual and customer documentation, will invalidate any warranty.



DANGER!

Risk of Injury by Incorrect Installation

Incorrect installation can cause injury to persons directly while the installation or during the subsequent startup

Note the Mounting Hint (see chapter 4, installation instruction)

The system startup has to be carried out by instructed qualified personnel that's familiar with

- the professional handling of security relevant components,
- the valid regulations for operational safety und rules for accident prevention.



DANGER!

Risk of Injury by Unintentional Startup

Rotating or moving of parts by inadvertent startup of the machine can cause injury .

During all mounting, demounting or repairing the system has to be powered-off. Note the mounting instructions.

**DANGER!****Risk of Injury by Movable Parts**

While normal operation, as well as inadvertent loosening of parts of the telemetry system during operation, present persons may be injured if protective equipment is absent.

Check the safety function of the protective equipment particularly

- before each startup
- after each replacement of a component
- after a longer standstill
- after each defect

Independent thereof the safety function of the protective equipment must be checked in suitable time intervals as part of the maintenance work!

**WARNING!****Risk of Burn Injury**

While operation the sensor signal amplifier and the stator antenna may become warm.

Avoid contact.

**CAUTION!****Risk of Property Damage**

If the connectors disconnected / connected while the system is powered on the telemetry system as well as the connected devices can be damaged.

Plug connectors must not be disconnected / connected when the system is powered on.

2 Conventional Usage

Sensor telemetry systems are used for contact-free data and power transfer from passive and active sensors (e.g. on rotating shafts).



DANGER!

Risk of Subsequent Damages caused by Malfunctions

If the telemetry system is used for controlling or regulating functions it is not conceivable for, subsequent damages up to injury to persons can be caused.

The delivered system has to be used exclusively used for the purpose for which it was ordered.

The operator must take care of his health and safety.

The operator of the equipment must prevent subsequent errors following faulty measuring results. This is particularly necessary if the telemetry system is used in controlling or regulating functions.

The customer, as the builder of a system with an integrated sensor telemetry system, is responsible for the correct and conform operation and also assumes the responsibility for ensuring that the system at start-up complies with all provisions of Directives 2014/53/EU and 2014/35/EU.

Scope of Delivery

A telemetry system normally contains:

- Evaluation unit
- Stator antenna
- Rotor antenna
- Sensor signal amplifier
- HF cable



For the detailed purchased parts package of the delivered telemetry system mind the corresponding shipping ticket.

3 Technical Data

3.1 Measuring System

Technical Data Telemetry System

Term	Value
HF frequency	13.56 MHz
Number of channels	1
Bandwidth	0 to 1 kHz (-3dB)
Linearity	<0.1%

General Measuring Configuration

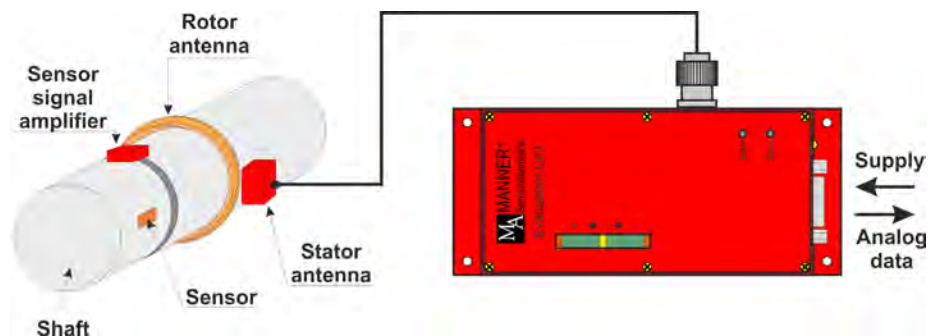

Fig. 1: General measuring configuration

Block Diagram

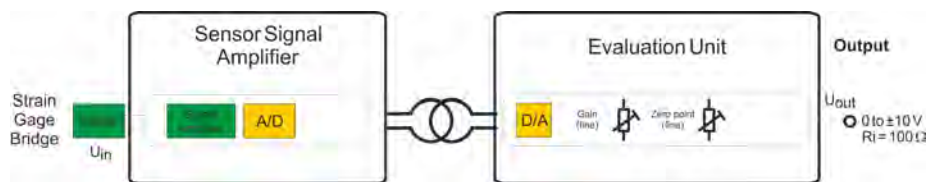

Fig. 2: Block diagram

Energy and Data Flow

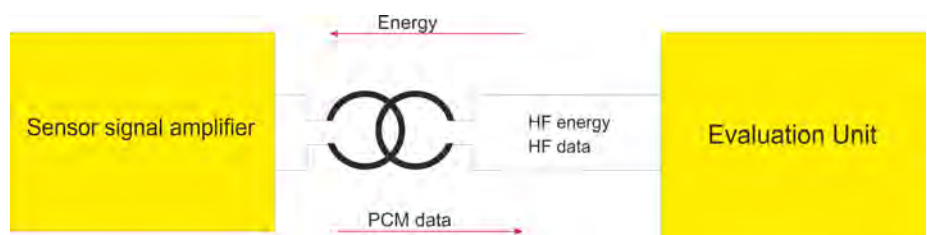

Fig. 3: Energy and data flow

3.2 Stator Antenna

Technical Data Stator Antenna

The connection between stator antenna and evaluation unit is realized by a coaxial cable.

Term	Value
Antenna type	A9c_PCM
Coaxial cable	RG58, 4 m, BNC to BNC
Supply	By evaluation unit
HF frequency	13.56 MHz
Protection class	IP42
Temperature range	-10 to +85°C

Scale Drawing Stator Antenna



CAUTION!

Damaging of Stator Antenna

Because of the transfer of vibrations by the cable the stator antenna may be damaged mechanically.

Establish a professional strain relief of the cable while installation of the stator antenna.

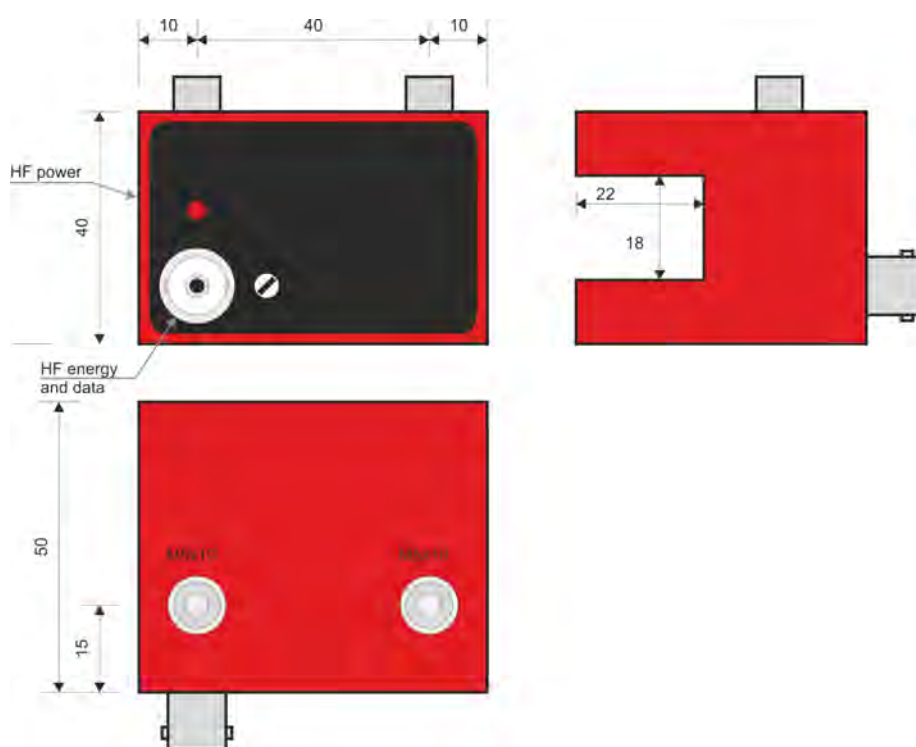

Fig. 4: Stator antenna A9c_PCM



See [Chapter 4.1.1 "Instruction for Installation Stator Antenna"](#) on page 11

4 Mounting / Starting

4.1 Coupling / Installation (*Example*)

Antenna Coupling



DANGER!

Risk of Faulty Measuring Data and Resulting Subsequent Errors, up to Injury to Persons

Damaging, modifications or disturbance of the coaxial cable(s) may falsify the measuring results and optionally cause subsequent errors according to operation purpose.

Do not buckle the coaxial cable!

Do not modify the coaxial cable!

Do not keep data cable and the coaxial cable together with energy- / high-power current cables!

The connectors of the HF energy and / or HF data coaxial cable must not have connection to the grounding of the machine!

Permissible bending radii for coaxial cables:

- RG58 → $R_B = 25$ mm
- RG400 → $R_B = 30$ mm static / 50 mm dynamic
- RG178 → $R_B = 15$ mm
- RG213 → $R_B = 50$ mm
- RG316 → $R_B = 15$ mm

The bending radii of the used coaxial cables must not be undercut



CAUTION!

Damaging of Antenna System

Contact between rotor antenna and stator antenna while operating may cause mechanical damages of the antennas

The stator antenna must not touch the rotor antenna.



CAUTION!

Risk of Damaging of Electronic, Faulty Measuring Data

While overheating of the evaluation unit the built-in electronics may be damaged

An overheated evaluation unit may cause faulty measuring values and respectively subsequent errors

The evaluation unit must be mounted onto a heat conductive base.



CAUTION!

Damaging of Evaluation Unit Caused by High Vibrancy

High Vibrancy of the evaluation unit may cause damaging

While mounting in environments with high vibrancy (e.g. in vehicles) the evaluation unit must be mounted vibration damped, e.g. by rubber buffer.



The stator antenna must be mounted directly opposite to the rotor antenna

The stator antenna must be mounted in the middle of the moving range of the rotor antenna

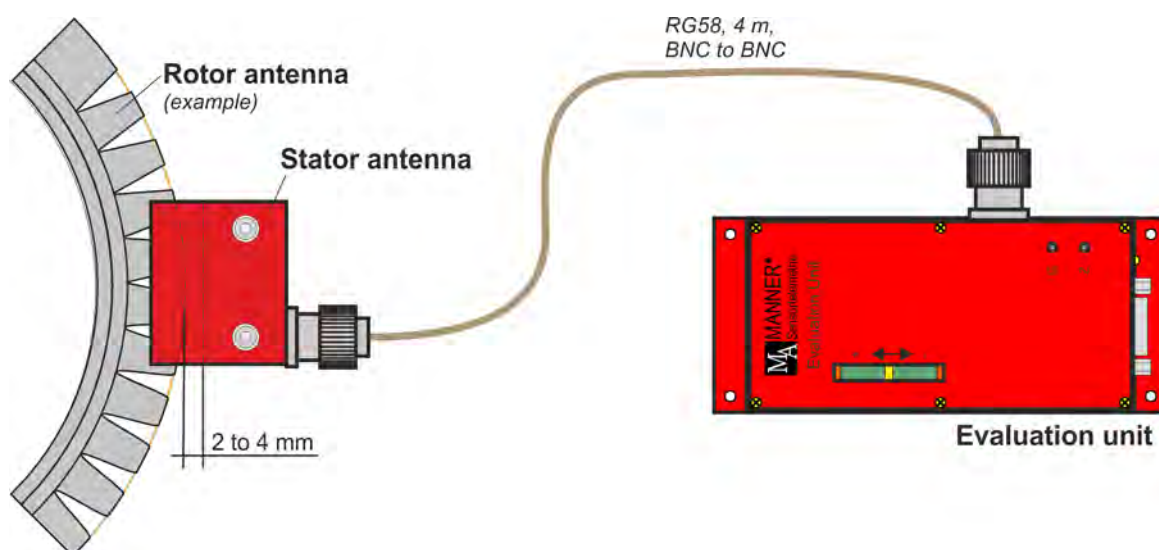

Fig. 5: Coupling

Startup



DANGER! **Risk of Injury**

Incorrect installation can cause injury to persons directly while the installation or during the subsequent startup

Follow mandatory the rules for accident prevention!

1. ▶ Mount the sensor signal amplifier with rotor antenna
2. ▶ Position the stator antenna correct to the rotor antenna
3. ▶ Connect the stator antenna with the evaluation unit
4. ▶ Switch the system on
5. ▶ Release the measuring position complete
6. ▶ Adjust the output signal to 0.000 V by using the screw '0'
7. ▶ Load the measuring position with nominal load or set the Cal.signal permanently
8. ▶ Adjust the output signal to +10.000 V by using the screw 'G' and measuring the "Analog output signal" or adjust to the value noted in the calibration protocol.
9. ▶ Release the measuring position complete or remove Cal.signal
10. ▶ Check the output signal to zero. Repeat step 5 to 10, if necessary.

4.1.1 Instruction for Installation Stator Antenna

Instruction for Installation Stator Antenna Type A9c



WARNING!

Risk of Faulty Measuring Data and Resulting Subsequent Errors up to Injury to Persons

Faulty measuring results may cause according to operation purpose further subsequent errors.

For error-free function of the antenna mind the minimum distance to the surrounding metal parts!



CAUTION!

Risk of Damaging of Stator Antenna

The antenna can be damaged mechanically if the mounting screws were tighten with to high torque.

Tightening torque of socket head screws max. 6 Nm!



CAUTION!

Risk Loosening of Stator Antenna Fixation and Damaging of the Antenna System

The stator antenna may unbolt by it-self during operation.

Secure the screws with removable locking varnish where required.

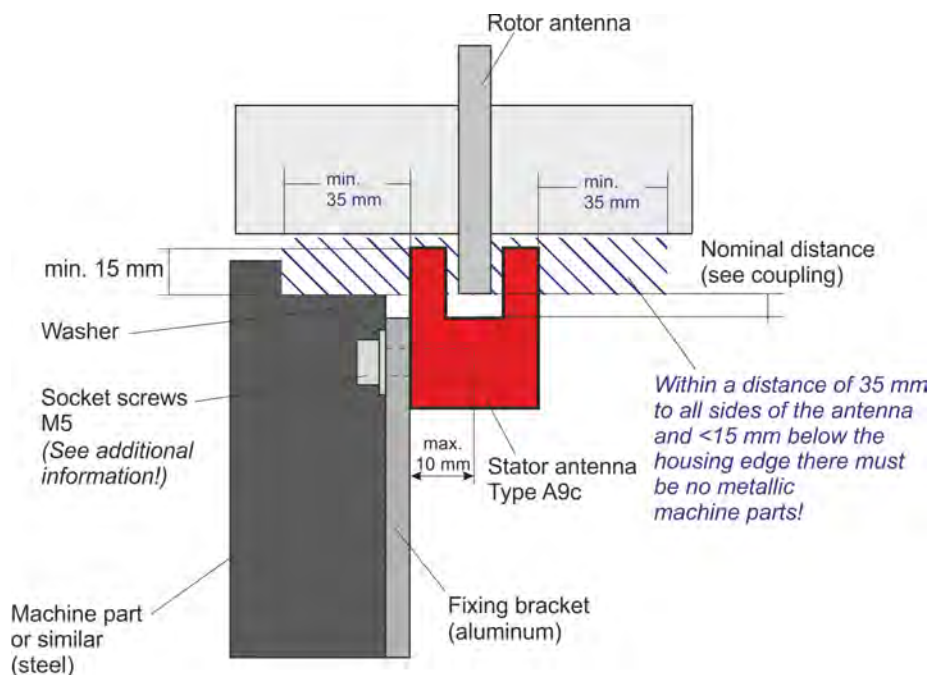

Fig. 6: Minimum distance antenna A9c

4.1.2 Adjustment of Stator Antenna

Adjustment



Execute this procedure only if the before described **Starting** of the measuring system does not work.

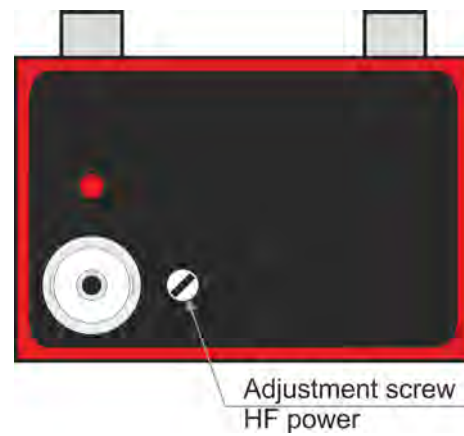

Fig. 7: Adjustment of stator antenna

- 1.** ► Build up the system, power on the measuring system.
- 2.** ► Define the optimum adjustment by left and right side tear-off edge.
- 3.** ► Balance for maximum power and function by adjustment screw .

This is the case when the red LED of the stator antenna is at maximum brightness.

5 Options

Optionally available

- waterproof
- ATF oilproof



If you have any questions regarding customer-specific solutions, please contact our sales department.

6 Maintenance

The systems of Manner Sensortelemetrie are low-maintenance.



DANGER!

Risk of Injury Caused by Defects on System Built-Up

Particularly loose or damaged parts may endanger present persons

Carry out the maintenance regularly and assiduously.

Within a periodical repeating maintenance following operations have to be done:

- Clean the antenna system, vacuuming of dust deposit
- Check the antenna system for scrub marks or mechanical damages
- Check the fastening of the stator antenna for a fix seat and tighten of the screwed fastenings where necessary.
- Check the plug connections and cables



Document the completed annual maintenance

7 Contact



MANNER Sensortelemetrie GmbH

Eschenwasen 20

D - 78549 - Spaichingen

Tel.: +49 7424 9329-0

Fax: +49 7424 9329-29

www.sensortelemetrie.de

info@sensortelemetrie.de